

E-HVDP

Rejilla de impulsión de aletas horizontales y verticales móviles



Descripción E-HVDP

Rejilla de impulsión con una primera fila de aletas horizontales unidas entre si y otra de aletas verticales también unidas que se posicionan mediante la acción de dos palancas. Fabricada con perfiles de aluminio extruido y anodizado.

Fijación:

- ✓ Muelles con marco de montaje E-MM, E-MAM- E-CLIPO o plenums montables E-PLEKIT (en las dimensiones en que el PLEKIT esté disponible).
- ✓ Pestillos acodados con marco de montaje E-MM
- ✓ Tornillos con marco E-MM

Acabado: Aluminio anodizado o blanco. Se pueden suministrar en otros colores bajo pedido.

Aplicaciones: Esta rejilla se utiliza en impulsiones en las que se debe cvambiar la dirección del aire con frecuencia. Sus palancas permiten realizar este cambio de una manera rápida.

Nota importante: La primera fila de aletas son horizontales y la segunda verticales.



Fijaciones E-HVDP

Muelles

1

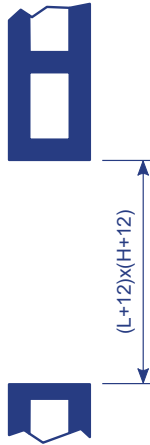

1. Abrir hueco en pared de medida (L+12) x (H+12).

2

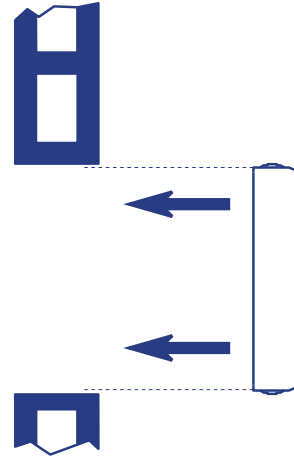

2. Colocar el marco metálico (E-MM o E-MAM). Fijarlo a la pared con mortero o yeso.

3

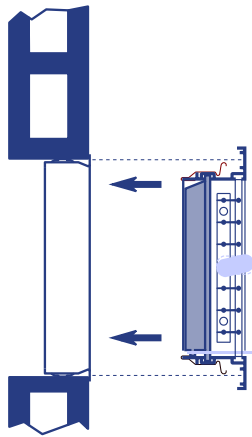

3. Colocar la rejilla con muelles dentro del marco metálico. Presionar primero un lado y luego el otro.



Fijaciones E-HVDP

Pestillos acodados

1

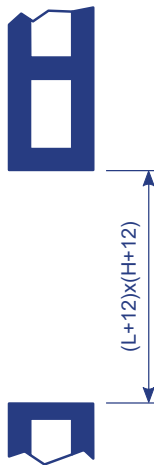

1. Abrir hueco en pared de medida (L+12) x (H+12)

2

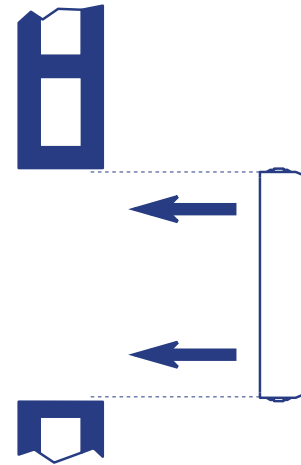

2. Colocar el marco metálico (E-MM o E-MAM). Fijarlo con mortero o yeso.

3

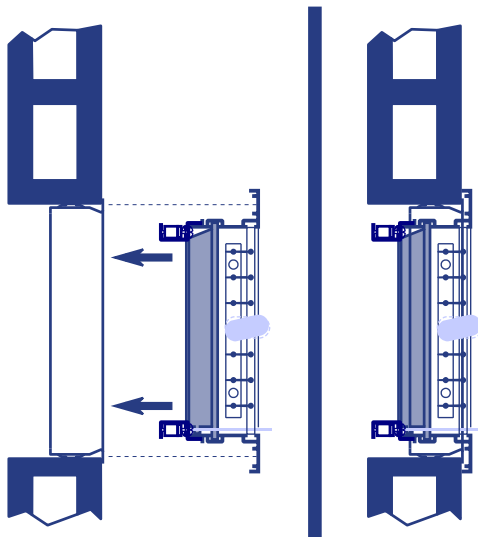

3. Colocar la rejilla con los pestillos cerrados.

4

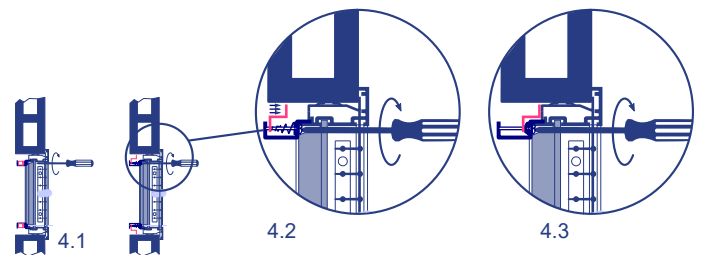

4.1 Girar tornillo mediante destornillador. El primer cuarto de vuelta la lengüeta del pestillo se coloca detrás del marco metálico.
4.2 Seguir girando el destornillador la lengüeta del pestillo se aproxima al marco.
4.3 La lengüeta se apoya con el marco. Cuando todos los pestillos de la rejilla están en esta posición la rejilla está completamente fijada.



Fijaciones E-HVDP

Tornillos

1

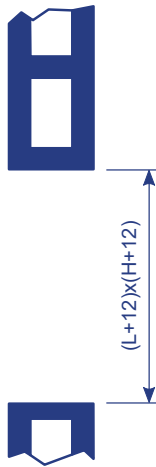

1. Abrir hueco en pared de medida (L+12) x (H+12)

2

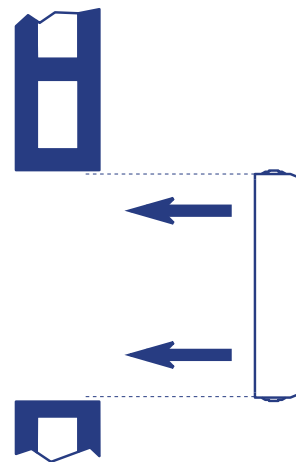

2. Colocar el marco metálico (E-MM o E-MAM). Fijarlo mediante mortero o yeso.

3

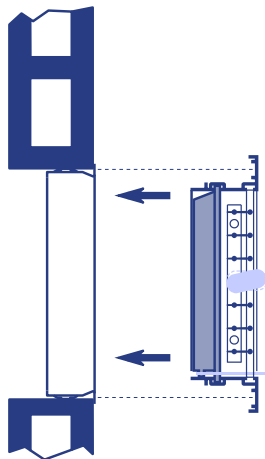

3. Colocar rejilla dentro del marco metálico.

4

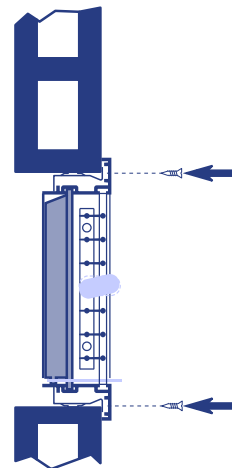

4. Colocar tornillos en los orificios del marco de la rejilla.

5

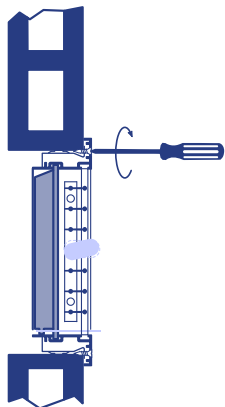

5. Atornillar.



Dimensiones E-HVDP

Las dimensiones nominales (de pedido) vienen marcadas por las cotas L y H.

MEDIDA DEL HUECO	
Sin marco de montaje	L x H
Con marco de montaje	(L+12) x (H+12)

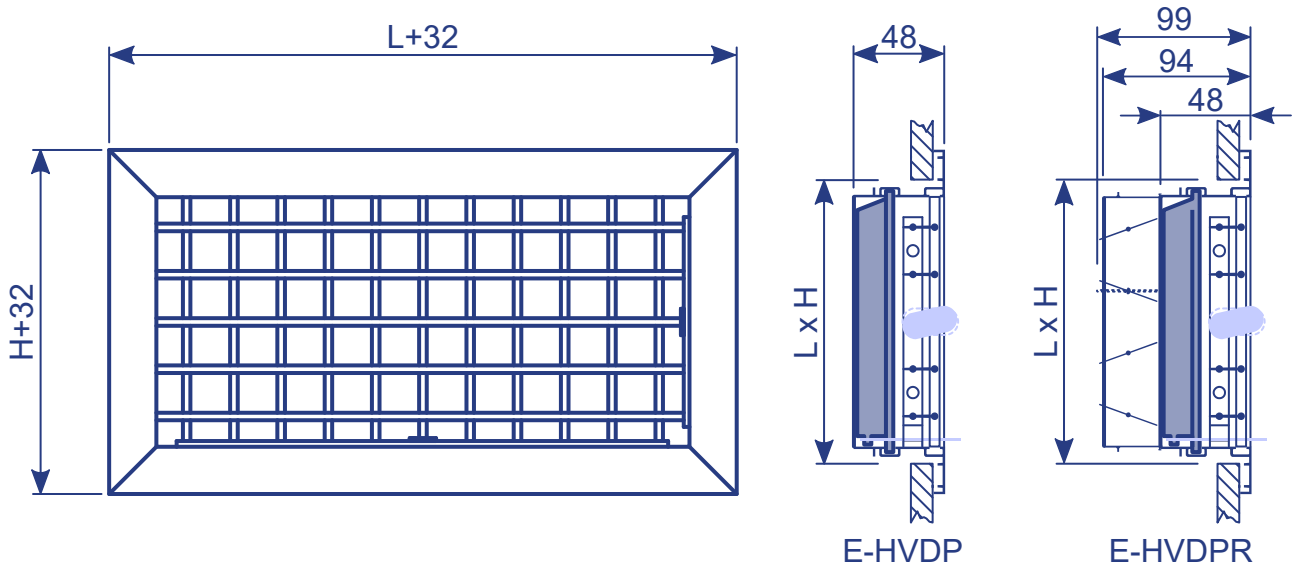

L \ H	100	150	200	250	300	350	400	450	500	600	700	800	900	1000
100	*	*	*	*	*	*	*	*	*	*	*	*	*	*
150	*	*	*	*	*	*	*	*	*	*	*	*	*	*
200	*	*	*	*	*	*	*	*	*	*	*	*	*	*
250	*	*	*	*	*	*	*	*	*	*	*	*	*	*
300	*	*	*	*	*	*	*	*	*	*	*	*	*	*
350	*	*	*	*	*	*	*	*	*	*	*	*	*	*
400	*	*	*	*	*	*	*	*	*	*	*	*	*	*
450	*	*	*	*	*	*	*	*	*	*	*	*	*	*
500	*	*	*	*	*	*	*	*	*	*	*	*	*	*

Nota: Las dimensiones indicadas en la tabla son estándar. Pueden fabricarse rejillas de otras dimensiones superiores o intermedias bajo pedido.



Difusión del aire E-HVDP

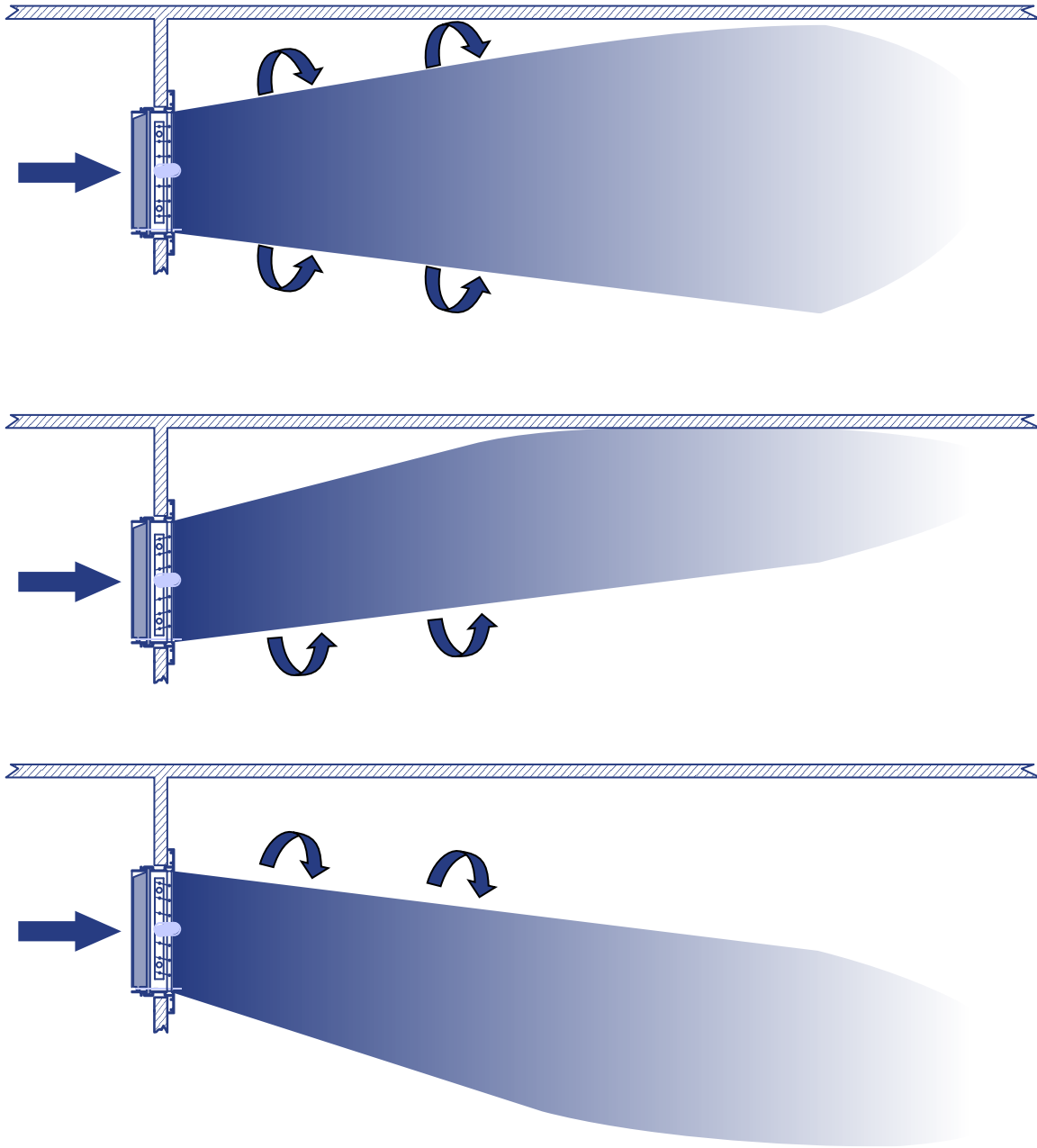



Accesorios E-HVDP

E-R: Compuerta de regulación de caudal de lamas opuestas, construido con perfiles de aluminio extruado. En posición de cierre las aletas quedan totalmente planas, mientras que en posición abierta las aletas quedan paralelas al flujo de aire.

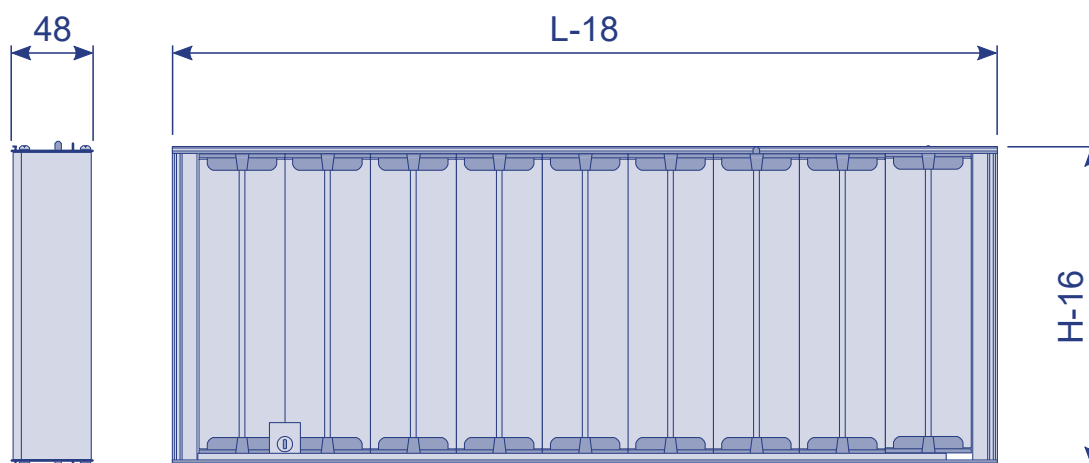

H \ L	150	200	250	300	350	400	450	500	550	600	650	700	750	800	850	900	950	1000
75	*	*	*	*	*	*	*	*	*	*	*	*	*	*	*	*	*	*
100	*	*	*	*	*	*	*	*	*	*	*	*	*	*	*	*	*	*
125	*	*	*	*	*	*	*	*	*	*	*	*	*	*	*	*	*	*
150	*	*	*	*	*	*	*	*	*	*	*	*	*	*	*	*	*	*
200	*	*	*	*	*	*	*	*	*	*	*	*	*	*	*	*	*	*
250	*	*	*	*	*	*	*	*	*	*	*	*	*	*	*	*	*	*
300	*	*	*	*	*	*	*	*	*	*	*	*	*	*	*	*	*	*
350	*	*	*	*	*	*	*	*	*	*	*	*	*	*	*	*	*	*
400	*	*	*	*	*	*	*	*	*	*	*	*	*	*	*	*	*	*

Nota 1: L y H son las dimensiones nominales de la rejilla.

Nota 2: Pueden fabricarse regulaciones de medidas especiales en cota H.

Nota 3: En cota L las regulaciones de caudal deben ser múltiplo de 50 mm. Cuando una rejilla sea de medida especial en cota L no múltiplo de 50 mm se colocará la regulación de mayor medida que sea múltiplo de 50 mm.

Nota 4: No son posibles regulaciones de caudal de más de 1000 x 400. En rejillas de mayor medida se colocarán varias regulaciones independientes.



Accesorios E-HVDP

Funcionamiento E-R:

1

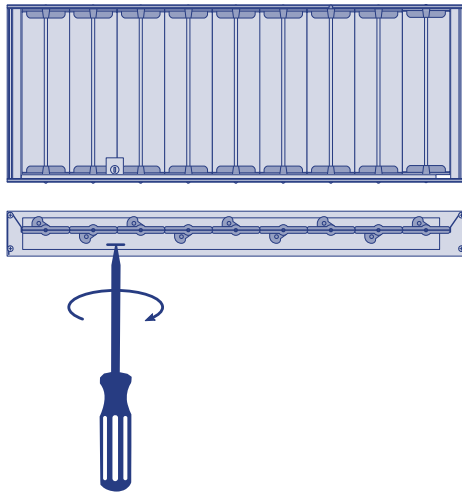

2

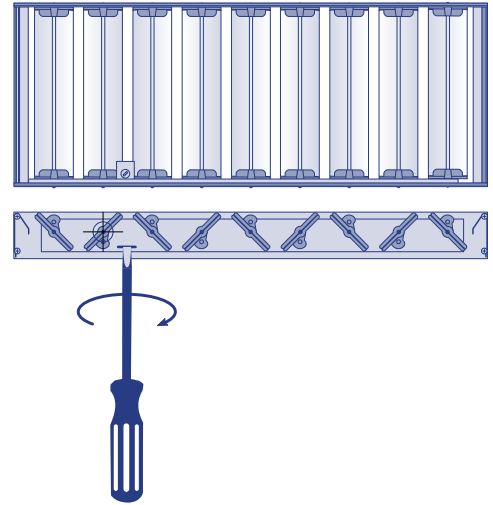

1. Girar corona mediante un destornillador hasta conseguir el grado de apertura deseado.

3

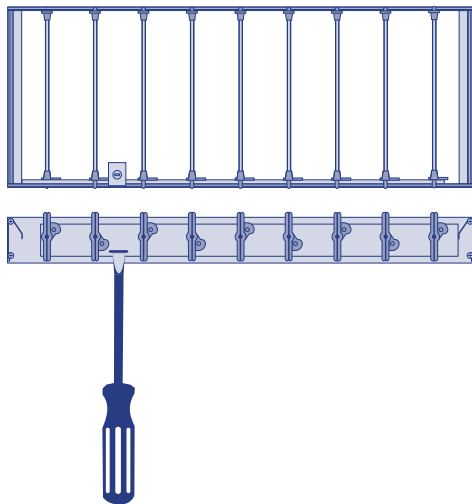



Accesorios E-HVDP

E-RM: Motorización de la compuerta de regulación. Puede ser de 24 V o 220 V, según se especifique en el pedido.

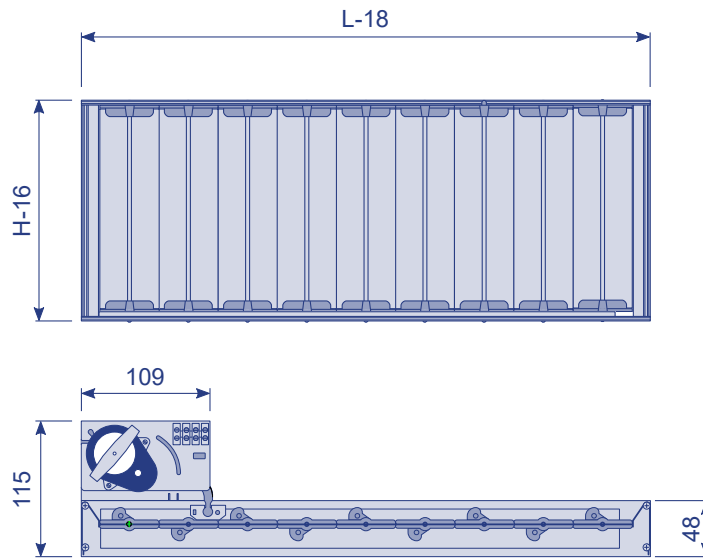

Esquema eléctrico:

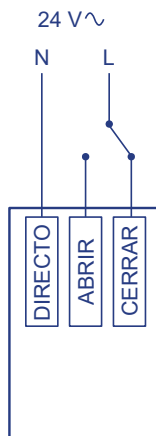
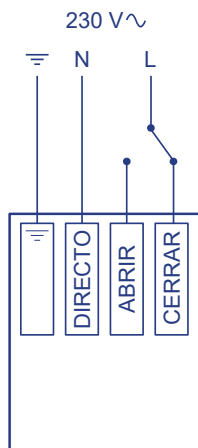

Características eléctricas	
Voltaje	230 / 24 V~
Tipo de actuación	Todo/nada
Tolerancia del voltaje	-10%.....+15%
Frecuencia	50 Hz
Potencia nominal	1,5 W
Control	3 puntos (todo - nada)
Final de carrera	No
Tiempo de maniobra (apertura o cierre)	12 s
Mantenimiento	No precisa
Temperatura de operación	-15....+55°C
Temperatura de almacenamiento	-20....+60°C



Plenums E-HVDP

02.276: Plénium montado realizado en chapa galvanizada con uno o más cuellos circulares (u ovalados) del mismo diámetro situado en el lado opuesto al que va colocado la rejilla.

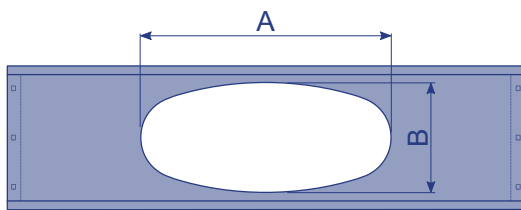
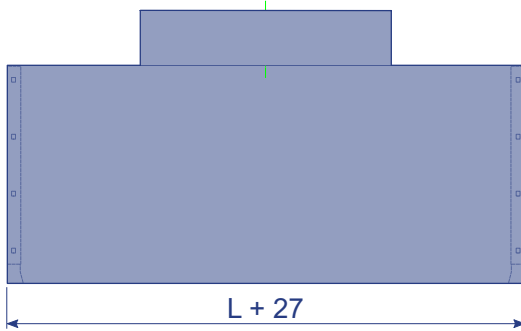

ØD _{cond.} (mm)	Tipo de cuello	A (mm)	B (mm)
100	Elíptico	107	90
	Circular	100	100
125	Elíptico	150	90
	Circular	125	125
150	Elíptico	190	90
	Circular	162	130
160	Elíptico	206	90
	Circular	178	130
200	Elíptico	270	90
	Circular	242	130
250	Elíptico	281	190
	Circular	250	250
300	Circular	300	300

Nota 1: Posibles otras cotas bajo pedido

Nota 2: Cota H mínima de rejilla B+10 mm

02.277: Plénium montado realizado en chapa galvanizada con uno o más cuellos circulares (u ovalados) del mismo diámetro situado en el lateral de la rejilla.

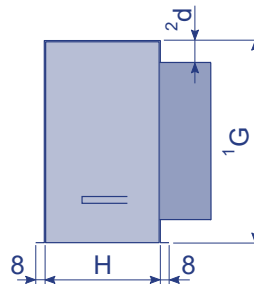
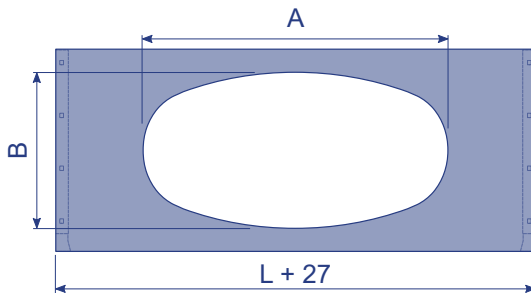

ØD _{cond.} (mm)	Tipo de cuello	A (mm)	B (mm)
100	Elíptico	107	90
	Circular	100	100
125	Elíptico	150	90
	Circular	125	125
150	Elíptico	190	90
	Circular	162	130
160	Elíptico	206	90
	Circular	178	130
200	Elíptico	270	90
	Circular	242	130
250	Elíptico	281	190
	Circular	250	250
300	Circular	300	300

Nota 1: Cota G según pedido

Nota 2: Cota mínima 25mm



Tablas de selección E-HVDP

ALTURA	LONGITUD										
400											
350											
300								300			400
250								300		400	500
200			200			300		400		500	600
150		200		300		400		500	600	700	800
100	200	300	400		500	600	700	800	900	1000	1200

Caudal
[m³/h]

100	Vel. [m/s]	2,8										
	P [mm.c.a.]	0,5										
	Nv. Son [dB(A)]	<15										
	Al. [m]	5,1										
150	Vel. [m/s]	4,2										
	P [mm.c.a.]	1,2										
	Nv. Son [dB(A)]	15										
	Al. [m]	7,5										
200	Vel. [m/s]	5,6										
	P [mm.c.a.]	2,1										
	Nv. Son [dB(A)]	22										
	Al. [m]	9,9										
300	Vel. [m/s]	8,4	5,4									
	P [mm.c.a.]	4,8	2									
	Nv. Son [dB(A)]	32	24									
	Al. [m]	14,7	10,7									
400	Vel. [m/s]		7,3	5,4	4,7							
	P [mm.c.a.]		3,5	1,9	1,4							
	Nv. Son [dB(A)]		31	25	22							
	Al. [m]		14,1	11,3	10,2							
500	Vel. [m/s]		9,1	6,7	5,8	5,3						
	P [mm.c.a.]		5,6	3	2,2	1,9						
	Nv. Son [dB(A)]		37	31	28	26						
	Al. [m]		17,5	14	12,6	11,8						
600	Vel. [m/s]			8,1	7	6,4	5,3	4,5				
	P [mm.c.a.]			4,4	3,2	2,7	1,9	1,4				
	Nv. Son [dB(A)]			35	32	31	27	24				
	Al. [m]			16,7	15	14,1	12,3	10,9				
700	Vel. [m/s]					7,5	6,2	5,3	4,6			
	P [mm.c.a.]					3,8	2,6	1,9	1,4			
	Nv. Son [dB(A)]					35	31	28	25			
	Al. [m]					16,4	14,2	12,7	11,5			
800	Vel. [m/s]						7,1	6	5,3	4,7	4,2	
	P [mm.c.a.]						3,4	2,4	1,9	1,5	1,2	
	Nv. Son [dB(A)]						34	31	29	26	24	
	Al. [m]						16,2	14,4	13	11,9	11	
900	Vel. [m/s]							6,8	5,9	5,3	4,7	
	P [mm.c.a.]							3,1	2,4	1,8	1,5	
	Nv. Son [dB(A)]							34	32	29	27	
	Al. [m]							16,2	14,6	13,4	12,4	
1000	Vel. [m/s]								6,6	5,8	5,2	4,4
	P [mm.c.a.]								2,9	2,3	1,8	1,3
	Nv. Son [dB(A)]								34	32	30	26
	Al. [m]								16,2	14,8	13,7	11,9

Vel = Velocidad efectiva P = Pérdida de carga Nv. Son = Nivel de ruido Al = Alcance del dardo de aire (0,25 m/s)



Tablas de selección E-HVDP

ALTURA	LONGITUD												
	500	600	700	800	900	400	500	600	700	800	900	1000	1200
500													
400					400		500	600	700	800	900	1000	1200
350				400		500	600	700	800	900	1000	1200	
300	300		400		500	600	700	800	900	1000	1200		
250		400	500		600	700	800	1000		1200			
200		500	600	700	800	900	1000	1200					
150	600	700	800	900	100	1200							
100	900	1000	1200										

Caudal
[m³/h]

1200	Vel. [m/s]	7	6,3	5,2	4,5	4								
	P [mm.c.a.]	3,3	2,7	1,8	1,3	1,1								
	Nv. Son [dB(A)]	36	34	31	28	26								
	Al. [m]	17,7	16,3	14,3	12,4	11,8								
1400	Vel. [m/s]			6,1	5,2	4,7	3,9							
	P [mm.c.a.]			2,5	1,8	1,5	1							
	Nv. Son [dB(A)]			35	32	29	26							
	Al. [m]			16,4	14,8	13,7	11,9							
1600	Vel. [m/s]				6	5,4	4,5	3,8						
	P [mm.c.a.]				2,4	1,9	1,3	1						
	Nv. Son [dB(A)]				35	33	29	26						
	Al. [m]				16,8	15,6	13,6	12,1						
1800	Vel. [m/s]					6,1	5	4,3	3,6					
	P [mm.c.a.]					2,4	1,7	1,2	0,8					
	Nv. Son [dB(A)]					36	32	29	25					
	Al. [m]					17,4	15,2	13,6	11,8					
2000	Vel. [m/s]						5,6	4,8	4	3,5	3,2			
	P [mm.c.a.]						2,1	1,5	1	0,8	0,6			
	Nv. Son [dB(A)]						35	32	28	25	24			
	Al. [m]						16,8	15	13,1	11,8	11,1			
2500	Vel. [m/s]								5	4,3	4	3,2		
	P [mm.c.a.]								1,6	1,2	1	0,7		
	Nv. Son [dB(A)]								34	31	29	25		
	Al. [m]								16,3	14,6	13,8	11,8		
3000	Vel. [m/s]									5,2	4,8	3,9	3,3	
	P [mm.c.a.]									1,7	1,5	1	0,7	
	Nv. Son [dB(A)]									36	34	30	27	
	Al. [m]									17,5	16,4	14,1	12,6	
3500	Vel. [m/s]											4,5	3,9	3,3
	P [mm.c.a.]											1,3	1	0,7
	Nv. Son [dB(A)]											34	31	28
	Al. [m]											16,3	14,6	13,1
4000	Vel. [m/s]												4,4	3,8
	P [mm.c.a.]												1,3	0,9
	Nv. Son [dB(A)]												34	31
	Al. [m]												16,6	14,9

Vel = Velocidad efectiva

P = Pérdida de carga

Nv. Son = Nivel de ruido

Al = Alcance del dardo de aire (0,25 m/s)



Tablas de selección E-HVDP

Áreas efectivas (m²) E-HVDP

H \ L	100	150	200	250	300	350	400	450	500	600	700	800	900	1000
100	0,005	0,007	0,010	0,013	0,015	0,018	0,021	0,023	0,026	0,031	0,037	0,042	0,048	0,053
150	0,007	0,011	0,015	0,020	0,024	0,028	0,032	0,036	0,041	0,049	0,057	0,066	0,074	0,082
200	0,010	0,016	0,022	0,028	0,034	0,039	0,045	0,051	0,057	0,069	0,081	0,092	0,104	0,116
250	0,013	0,0220	0,027	0,035	0,042	0,049	0,057	0,064	0,072	0,086	0,101	0,116	0,131	0,146
300	0,015	0,025	0,034	0,043	0,052	0,061	0,070	0,079	0,088	0,106	0,124	0,142	0,161	0,179
350	0,018	0,029	0,039	0,050	0,060	0,071	0,082	0,092	0,103	0,124	0,146	0,166	0,187	0,209
400	0,021	0,033	0,045	0,058	0,070	0,082	0,094	0,107	0,119	0,144	0,168	0,192	0,217	0,242
450	0,023	0,037	0,051	0,065	0,079	0,092	0,106	0,120	0,134	0,161	0,189	0,216	0,244	0,272
500	0,026	0,042	0,057	0,073	0,088	0,104	0,119	0,135	0,150	0,181	0,212	0,243	0,274	0,305

Ejemplo de selección de rejilla

Datos:

Caudal a impulsar Q = 600 m³/h

Nivel sonoro Nv. Son = 30 dB(A)

ALTURA	LONGITUD													
400														
350														
300											300		400	
250										300		400	500	
200				200				300		400		500	600	
150			200	300				400		500	600	700	800	
100		200	300	400	500	600	700	800	900	1000	1200			

Caudal
[m³/h]

600	Vel. [m/s]			8,1	7	6,4	5,3	4,5						
	P [mm.c.a.]			4,4	3,2	2,7	1,9	1,4						
	Nv. Son [dB(A)]			35	32	31	27	24						
	Al. [m]			16,7	15	14,1	12,3	10,9						

Resultados:

Medida 600 mm x 100 mm

Velocidad Vel = 5,3 m/s

Pérdida de carga P = 1,9 mm.c.a.

Nivel sonoro Nv. Son = 27 dB(A)

Alcance = 12,3 m



Referencia de pedido

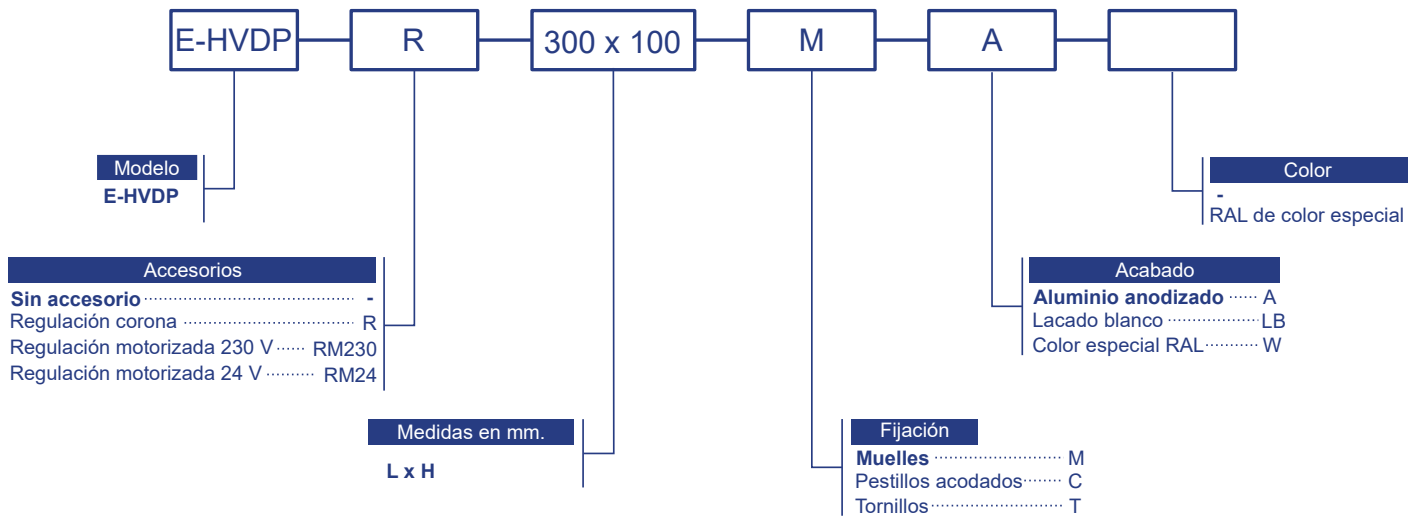

Nota: Las opciones señaladas en negrita serán las que se utilizarán en caso de no especificación por parte del cliente.

Ejemplo: E-HVDP-300x100-M-LB: Rejilla HVDP con las lamas horizontales en la primera fila de 300 mm de longitud y 100 mm de altura con fijación por muelles y lacado en blanco.